

**Atraumatische Bulldogklemmen**  
**Atrauma Bulldog Clamps**  
**Clamps Bulldog atraumatiques**  
**Clamps Bulldog atraumáticos**



**DE BAKEY**



**07-0070.07**

7,5 cm, 3"



**07-0070.08**

8,5 cm, 3 1/2"



**07-0070.10**

10,5 cm, 4"



**07-0070.12**

12 cm, 4 3/4"



**07-0071.07**

7,5 cm, 3"



**07-0071.08**

8,5 cm, 3 1/2"



**07-0071.10**

10,5 cm, 4"



**07-0071.12**

12 cm, 4 3/4"



**GLOVER**



**07-0150.06**

6 cm, 2 1/2"



**07-0150.07**

7 cm, 2 3/4"



**07-0150.09**

9 cm, 3 1/2"



**07-0150.11**

11 cm, 4 1/4"



**07-0151.06**

5,5 cm, 2 1/4"



**07-0151.07**

6,5 cm, 2 3/4"



**07-0151.09**

8,5 cm, 3 1/2"



**07-0151.11**

10,5 cm, 4"

07

Arterienklemmen  
 Hemostatic Forceps  
 Pincas hémostatiques  
 Pinzas hemostáticas



07-0160.04

3,5 cm, 1 1/2"

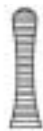

07-0160.05

5,5 cm, 2 1/4"



07-0161.04

3,5 cm, 1 1/2"



07-0161.05

5,5 cm, 2 1/4"



DIEFFENBACH



07-0170.50

5 cm, 2"



07-0170.55

5,5 cm, 2 1/4"

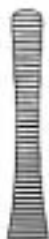

07-0170.65

6,5 cm, 2 3/4"

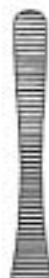

07-0170.70

7 cm, 3"



07-0170.75

7,5 cm, 3 1/4"



07-0170.90

9 cm, 3 1/2"



07-0171.50

5 cm, 2"



07-0171.55

5,5 cm, 2 1/4"



07-0171.65

6,5 cm, 2 3/4"



07-0171.70

7 cm, 3"



07-0171.75

7,5 cm, 3 1/4"



07-0171.90

9 cm, 3 1/2"



JOHNS-HOPKINS

Arterienklemmen  
Hemostatic Forceps  
Pinces hémostatiques  
Pinzas hemostáticas



07-0520.10  
10 cm, 4"



07-0521.10  
10 cm, 4"

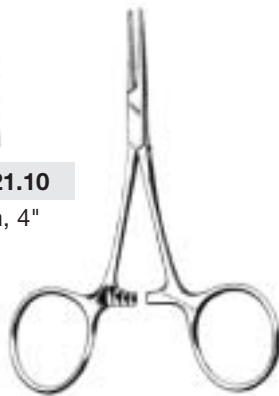

HARTMANN



07-0522.10  
10 cm, 4"



07-0523.10  
10 cm, 4"



HARTMANN



07-0600.12  
12,5 cm, 5"



07-0601.12  
12,5 cm, 5"

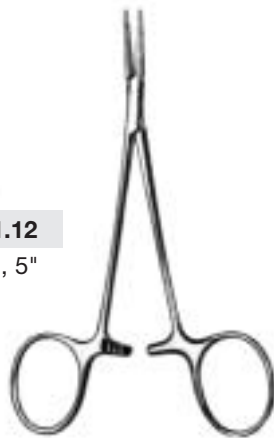

MICRO-MOSQUITO



07-0602.12  
12,5 cm, 5"



07-0603.12  
12,5 cm, 5"



MICRO-MOSQUITO

Arterienklemmen  
 Hemostatic Forceps  
 Pinces hémostatiques  
 Pinzas hemostáticas



**HALSTEAD-MOSQUITO**

07-0620.12	12,5 cm, 5"
07-0620.14	14 cm, 5 1/2"
07-0620.18	18 cm, 7"
07-0620.21	21 cm, 8 1/4"



**HALSTEAD-MOSQUITO**

07-0621.12	12,5 cm, 5"
07-0621.14	14 cm, 5 1/2"
07-0621.18	18 cm, 7"
07-0621.21	21 cm, 8 1/4"



**HALSTEAD-MOSQUITO**

07-0622.12	12,5 cm, 5"
07-0622.14	14 cm, 5 1/2"
07-0622.18	18 cm, 7"
07-0622.21	21 cm, 8 1/4"



**HALSTEAD-MOSQUITO**

07-0623.12	12,5 cm, 5"
07-0623.14	14 cm, 5 1/2"
07-0623.18	18 cm, 7"
07-0623.21	21 cm, 8 1/4"

Arterienklemmen  
 Hemostatic Forceps  
 Pinces hémostatiques  
 Pinzas hemostáticas



07-0800.14  
 14 cm, 5 1/2"



06-0801.14  
 14 cm, 5 1/2"



KELLY



07-0802.16  
 16 cm, 6 1/2"



07-0803.16  
 16 cm, 6 1/2"



KELLY-RANKIN



07-0820.14  
 14 cm, 5 1/2"



07-0821.14  
 14 cm, 5 1/2"



CRILE



07-0822.14  
 14 cm, 5 1/2"



07-0823.14  
 14 cm, 5 1/2"



CRILE

07

Arterienklemmen  
 Hemostatic Forceps  
 Pinces hémostatiques  
 Pinzas hemostáticas



07-0826.16  
 16 cm, 6 1/2"



07-0827.16  
 16 cm, 6 1/2"



CRILE-RANKIN



07-0828.16  
 16 cm, 6 1/2"



07-0829.16  
 16 cm, 6 1/2"



CRILE-RANKIN



07-0726.14  
 14 cm, 5 1/2"



07-0727.14  
 14 cm, 5 1/2"

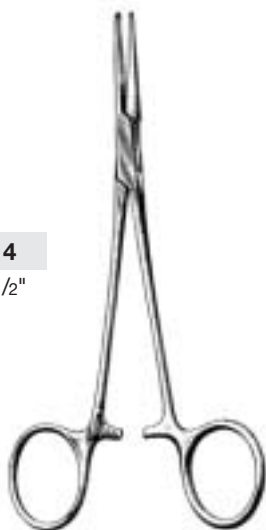

PROVIDENCE-HOSPITAL



07-0930.14  
 14 cm, 5 1/2"



07-0931.14  
 14 cm, 5 1/2"

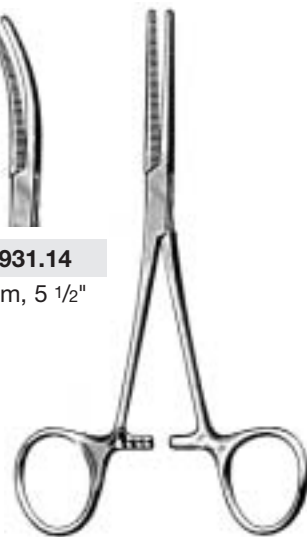

PEAN

Arterienklemmen  
Hemostatic Forceps  
Pinces hémostatiques  
Pinzas hemostáticas

07



07-0940.13

13 cm, 5"



07-0940.14

14 cm, 5 1/2"



07-0940.16

16 cm, 6 1/2"



07-0940.18

18 cm, 7"

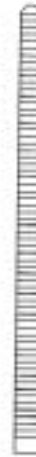

07-0940.20

20 cm, 8"



07-0940.22

22 cm, 8 1/2"



07-0940.24

24 cm, 9 1/2"



07-0940.26

26 cm, 10 1/4"



07-0940.28

28 cm, 11"



07-0940.30

30 cm, 12"



ROCHESTER-PEAN



Arterienklemmen  
 Hemostatic Forceps  
 Pinces hémostatiques  
 Pinzas hemostáticas

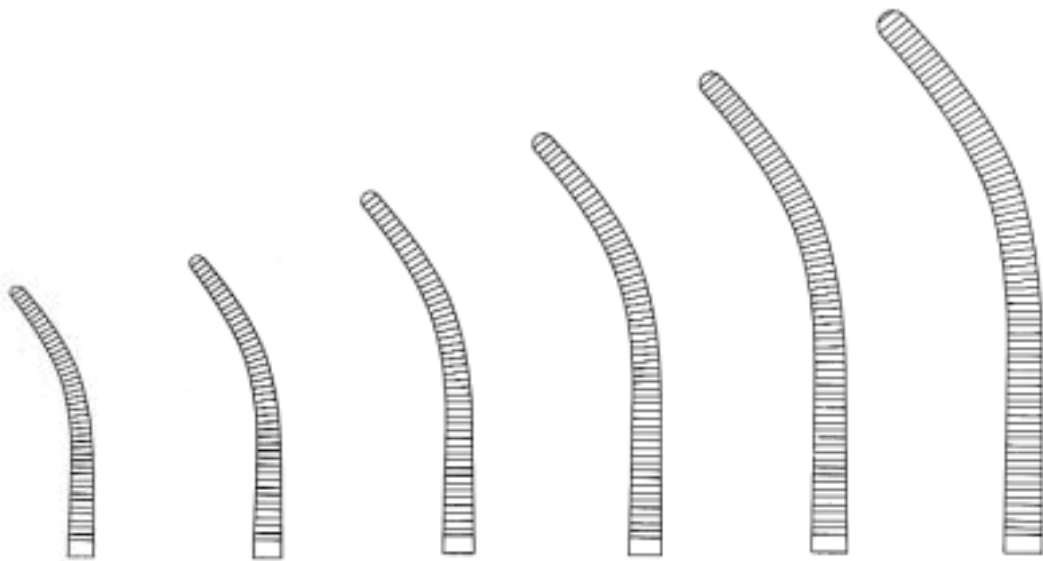

<b>07-0941.13</b>	<b>07-0941.14</b>	<b>07-0941.16</b>	<b>07-0941.18</b>	<b>07-0941.20</b>	<b>07-0941.22</b>
13 cm, 5"	14 cm, 5 1/2"	16 cm, 6 1/2"	18 cm, 7"	20 cm, 8"	22 cm, 8 1/2"

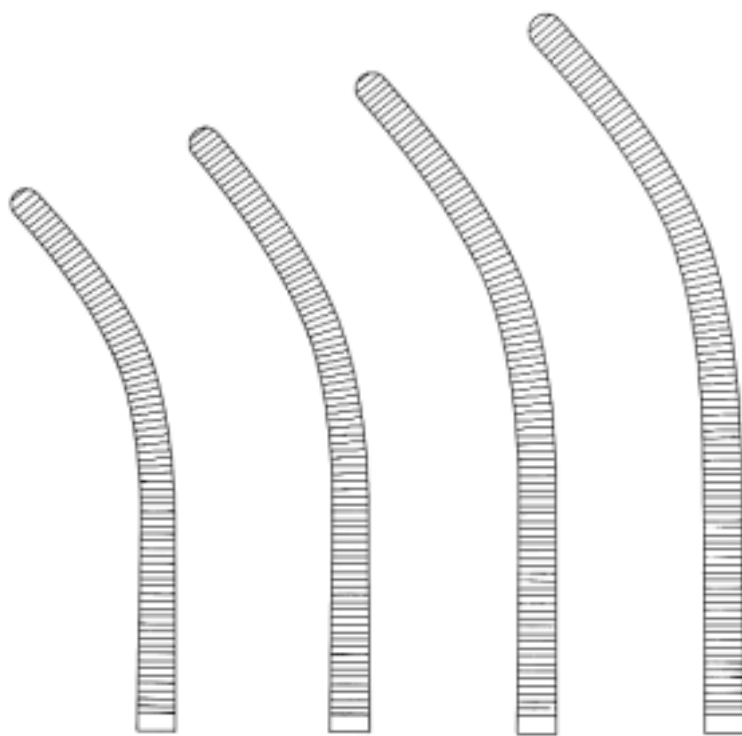

<b>07-0941.24</b>	<b>07-0941.26</b>	<b>07-0941.28</b>	<b>07-0941.30</b>
24 cm, 9 1/2"	26 cm, 10 1/4"	28 cm, 11"	30 cm, 12"



**ROCHESTER-PEAN**

Arterienklemmen  
 Hemostatic Forceps  
 Pinces hémostatiques  
 Pinzas hemostáticas

07



**07-1030.13**  
 13 cm, 5"



**07-1030.14**  
 14 cm, 5 1/2"



**07-1030.16**  
 16 cm, 6 1/2"



**07-1030.18**  
 18 cm, 7"



**07-1030.20**  
 20 cm, 8"



**07-1030.22**  
 22 cm, 8 1/2"



**07-1030.24**  
 24 cm, 9 1/2"



**07-1030.26**  
 26 cm, 10 1/4"



**07-1030.28**  
 28 cm, 11"



**07-1030.30**  
 30 cm, 12"



**ROCHESTER-OSHSNER**

Arterienklemmen  
 Hemostatic Forceps  
 Pinces hémostatiques  
 Pinzas hemostáticas

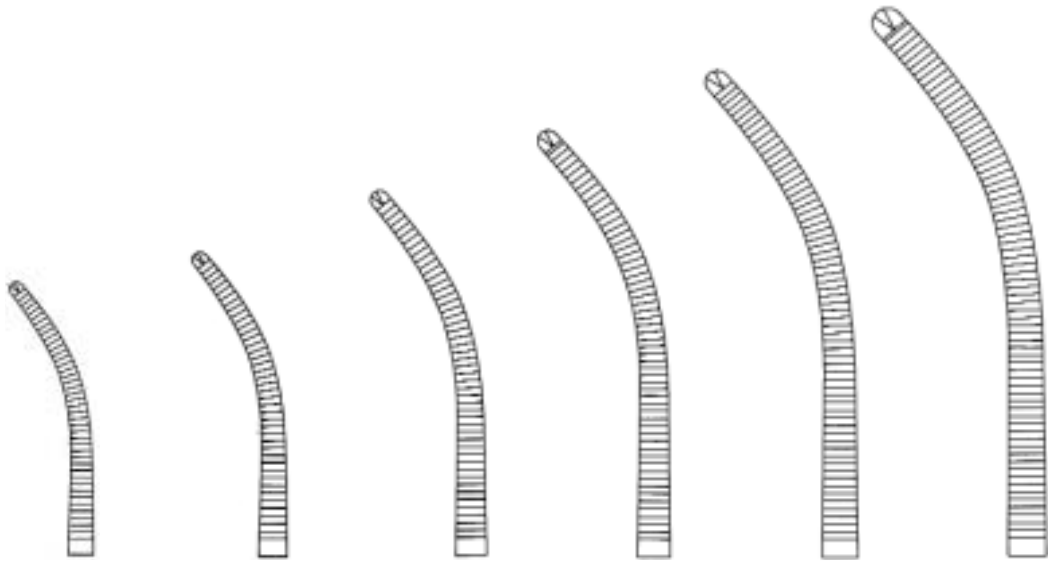

<b>07-1031.13</b>	<b>07-1031.14</b>	<b>07-1031.16</b>	<b>07-1031.18</b>	<b>07-1031.20</b>	<b>07-1031.22</b>
13 cm, 5"	14 cm, 5 1/2"	16 cm, 6 1/2"	18 cm, 7"	20 cm, 8"	22 cm, 8 1/2"

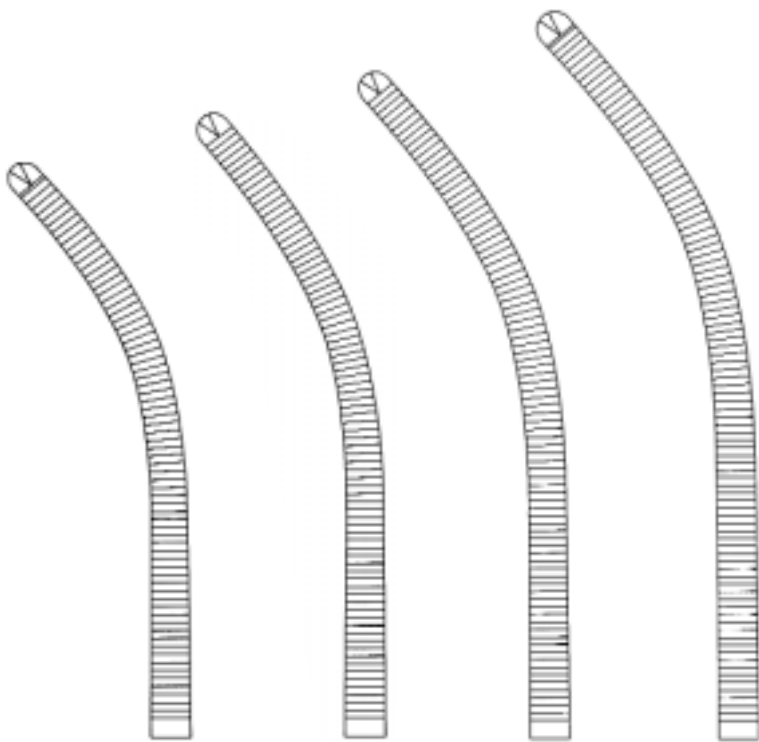

<b>07-1031.24</b>	<b>07-1031.26</b>	<b>07-1031.28</b>	<b>07-1031.30</b>
24 cm, 9 1/2"	26 cm, 10 1/4"	28 cm, 11"	30 cm, 12"



**ROCHESTER-OCHSNER**

Arterienklemmen  
 Hemostatic Forceps  
 Pinces hémostatiques  
 Pinzas hemostáticas



07-1028.14  
 14 cm, 5 1/2"



07-1029.14  
 14 cm, 5 1/2"



KOCHER



07-1050.14  
 14 cm, 5 1/2"



07-1051.14  
 14 cm, 5 1/2"



SPENCER-WELLS



07-0860.16  
 16 cm, 6 1/2"



07-0861.16  
 16 cm, 6 1/2"



07-0860.18  
 18 cm, 7"



07-0861.18  
 18 cm, 7"



ROCHESTER-CARMALT

07

Arterienklemmen  
 Hemostatic Forceps  
 Pinces hémostatiques  
 Pinzas hemostáticas

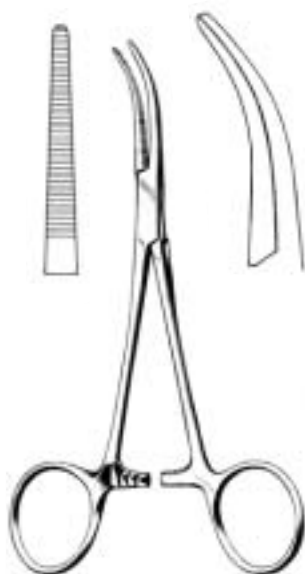

**DANDY**  
 07-0671.14  
 14 cm, 5 1/2"

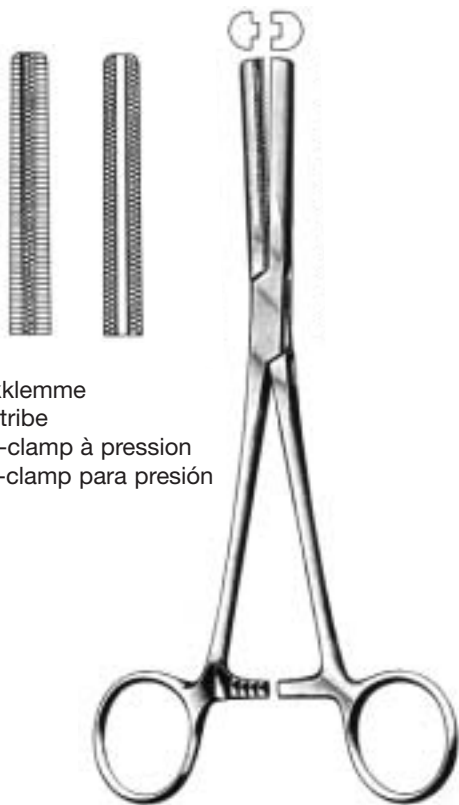

Druckklemme  
 Angiotribe  
 Pince-clamp à pression  
 Pinza-clamp para presión

**FERGUSON**  
 07-4524.16  
 16 cm, 6 1/2"

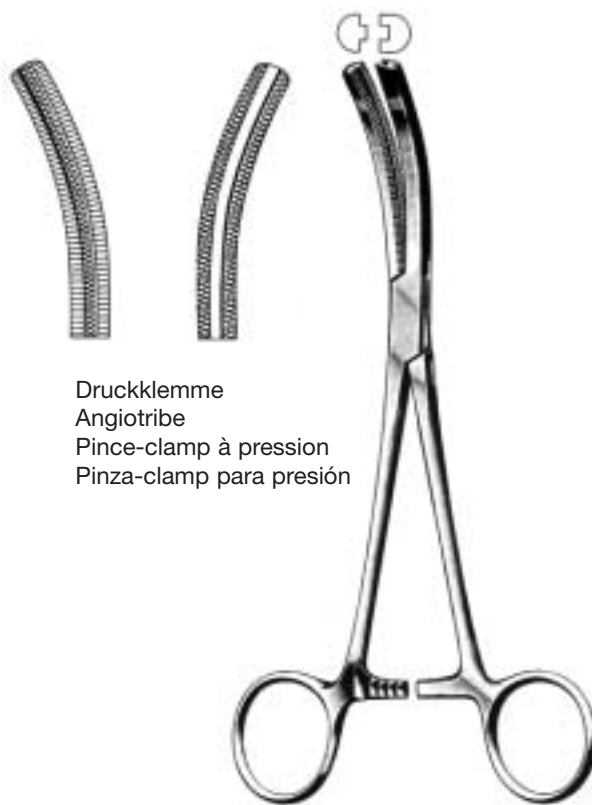

Druckklemme  
 Angiotribe  
 Pince-clamp à pression  
 Pinza-clamp para presión

**FERGUSON**  
 07-4525.16  
 16 cm, 6 1/2"

Arterienklemmen, Gewebefaßzangen  
 Hemostatic Forceps, Intestinal Tissue Forceps  
 Pincés hémostatiques, Pincés pour saisir le tissu  
 Pinzas hemostáticas, Pinzas para coger tejidos



**LOVELACE**  
 07-4377.15  
 15,5 cm, 6"



**PENNINGTON**  
 07-4372.15  
 15 cm, 5 3/4"



**PRATT**  
 07-4504.15  
 15 cm, 5 3/4"



**DeMARTEL**  
 07-4501.14  
 14 cm, 5 1/2"



**WILLET-MARTEL**  
 07-4501.19  
 19 cm, 7 1/2"



**PEAN**  
 07-0920.14  
 14 cm, 5 1/2"

07

Arterienklemmen  
Hemostatic Forceps  
Pinces hémostatiques  
Pinzas hemostáticas

---



**CHAPUT**

07-4312.13

13 cm, 5"



**TUFFIER**

07-4310.13

13 cm, 5"



**COLLIN**

07-4350.14

14 cm, 5 1/2"



**COLLIN**

07-4542.16

16 cm, 6 1/2"

Arterienklemmen  
 Hemostatic Forceps  
 Pinces hémostatiques  
 Pinzas hemostáticas



07-0710.15

15 cm, 5 3/4"



07-0711.15

15 cm, 5 3/4"



LERICHE



07-0712.15

15 cm, 5 3/4"



07-0713.15

15 cm, 5 3/4"



LERICHE



07-0774.20

20 cm, 8"



07-0775.20

20 cm, 8"



BENGOLEA



07-0776.20

20 cm, 8"



07-0777.20

20 cm, 8"



BENGOLEA

07-0774.26

26 cm, 10 1/4"

07-0775.26

26 cm, 10 1/4"

07-0776.26

26 cm, 10 1/4"

07-0777.26

26 cm, 10 1/4"



Arterienklemmen  
 Hemostatic Forceps  
 Pinces hémostatiques  
 Pinzas hemostáticas



07-0730.20

20 cm, 8"



07-0731.20

20 cm, 8"



07-0733.20

20 cm, 8"



HEISS



07-0650.19

19 cm, 7 1/2"



07-0651.19

19 cm, 7 1/2"



ADSON

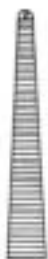

07-0652.19

19 cm, 7 1/2"

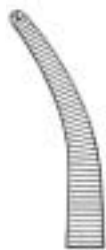

07-0653.19

19 cm, 7 1/2"



ADSON



ADSON-BABY

07-0655.18

18,5 cm, 7 1/4"

**Präparier- und Ligaturklemmen**  
**Dissecting and Ligature Forceps**  
**Pinces à dissection et à ligatures**  
**Pinzas para disección y ligaduras**

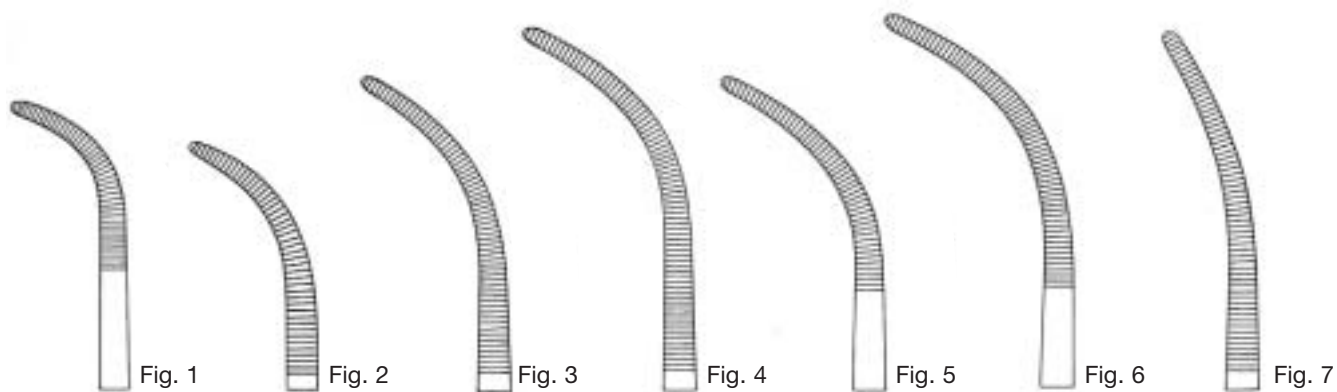

**07-1711.01**

21 cm, 8 1/4"

**07-1711.02**

21 cm, 8 1/4"

**07-1711.03**

21 cm, 8 1/4"

**07-1711.04**

21 cm, 8 1/4"

**07-1711.05**

21 cm, 8 1/4"

**07-1711.06**

21 cm, 8 1/4"

**07-1711.07**

21 cm, 8 1/4"

**07-1713.01**

27 cm, 10 1/2"

**07-1713.02**

27 cm, 10 1/2"

**07-1713.03**

27 cm, 10 1/2"

**07-1713.04**

27 cm, 10 1/2"

**07-1713.05**

27 cm, 10 1/2"

**07-1713.06**

27 cm, 10 1/2"

**07-1713.07**

27 cm, 10 1/2"



**OVERHOLT-GEISSENDOERFER**

07

**Präparier- und Ligaturklemmen**  
**Dissecting and Ligature Forceps**  
**Pinces à dissection et à ligatures**  
**Pinzas para disección y ligaduras**

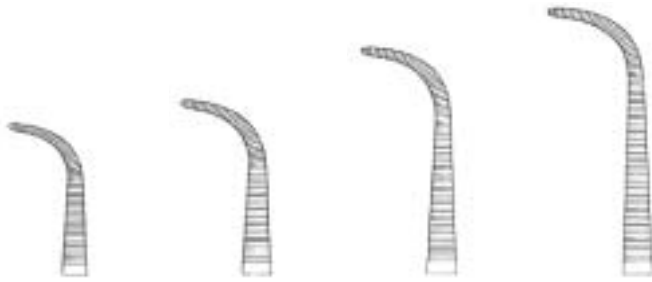

**07-1743.13**

13 cm, 5"



**07-1743.16**

16 cm, 6 1/4"

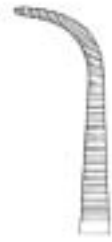

**07-1743.18**

18 cm, 7"

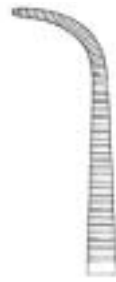

**07-1743.20**

20 cm, 8"

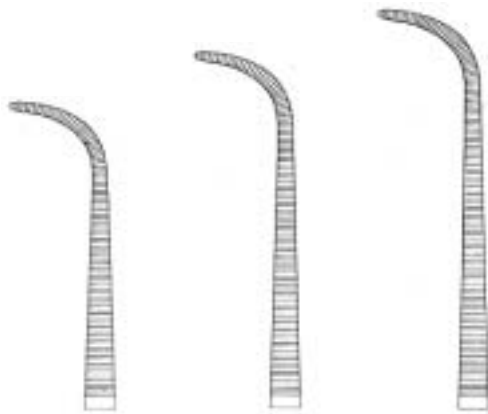

**07-1743.23**

23 cm, 9"

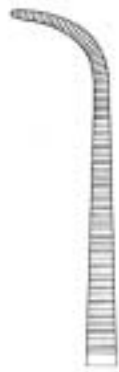

**07-1743.25**

25 cm, 10"

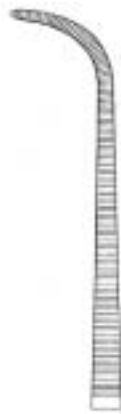

**07-1743.28**

28 cm, 11"

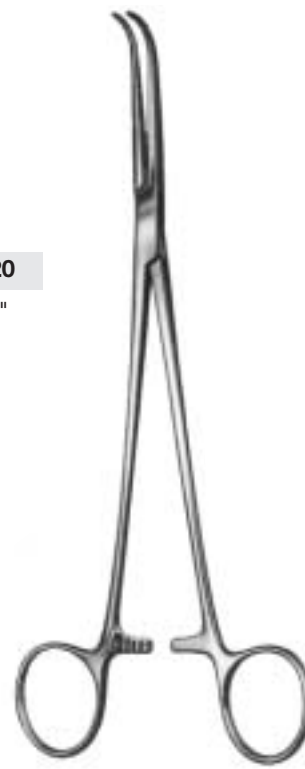

**GEMINI**

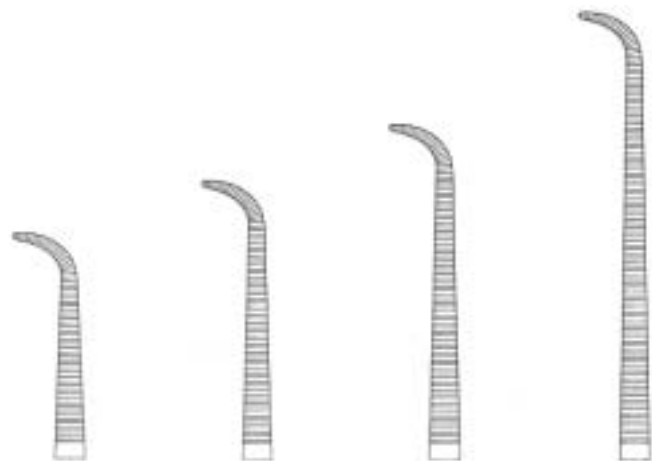

**07-1745.18**

18 cm, 7"

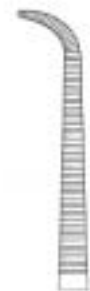

**07-1745.22**

22 cm, 8 1/2"

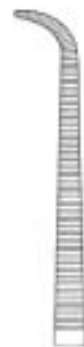

**07-1745.25**

25 cm, 10"

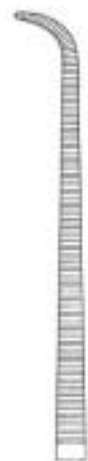

**07-1745.28**

28 cm, 11"



**GEMINI (MIXTER)**

**Präparier- und Ligaturklemmen**  
**Dissecting and Ligature Forceps**  
**Pinces à dissection et à ligatures**  
**Pinzas para disección y ligaduras**

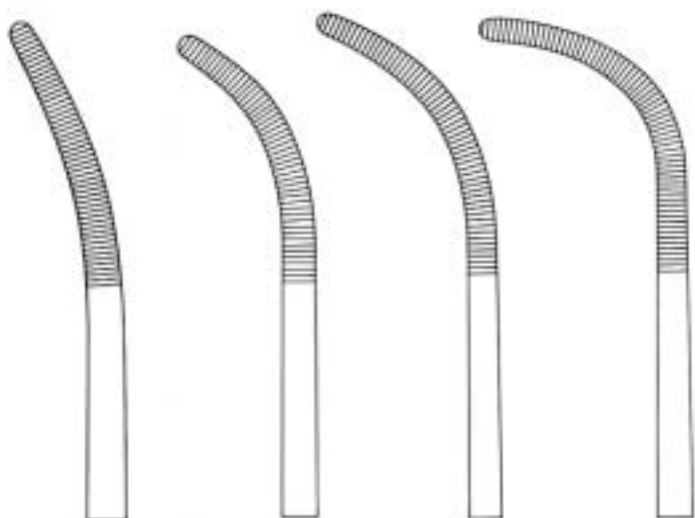

07-1701.01

23 cm, 9"

07-1701.02

23 cm, 9"

07-1701.03

23 cm, 9"

07-1701.04

23 cm, 9"



RUMMEL

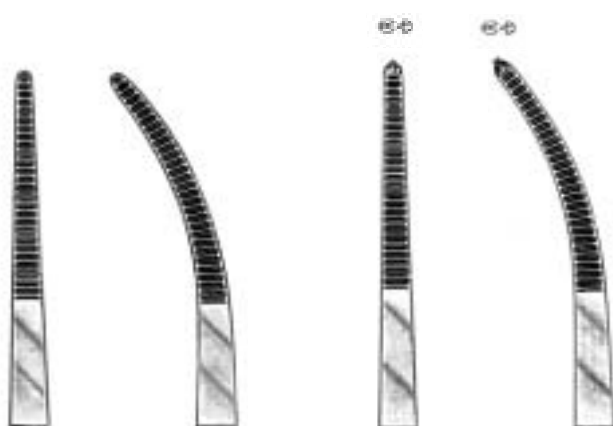

07-1080.21

21 cm, 8 1/4"

07-1081.21

21 cm, 8 1/4"

07-1082.21

21 cm, 8 1/4"

07-1083.21

21 cm, 8 1/4"



TOENNIS

07

**Präparier- und Ligaturklemmen**  
**Dissecting and Ligature Forceps**  
**Pinces à dissection et à ligatures**  
**Pinzas para disección y ligaduras**

**Bronchusklemmen**  
**Bronchus Forceps**  
**Pinces-clamps bronchiques**  
**Pinzas-clamps para bronquios**



**07-1070.22**  
22 cm, 8 1/2"

**07-1071.22**  
22 cm, 8 1/2"



**ROBERTS**



**07-1066.24**  
24 cm, 9 1/2"

**07-1067.24**  
24 cm, 9 1/2"



**SAROT**



**CRAFOORD**  
**07-0751.24**  
24 cm, 9 1/2"

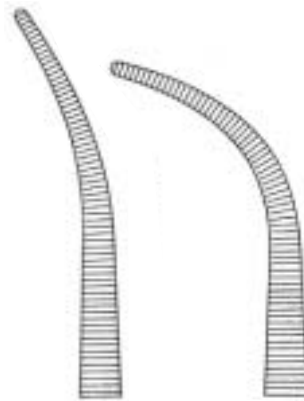

**07-1059.01**    **07-1059.02**  
29,5 cm, 11 1/2"    29,5 cm, 11 1/2"



**ZENKER**

**Präparier- und Ligaturklemmen**  
**Dissecting and Ligature Forceps**  
**Pinces à dissection et à ligatures**  
**Pinzas para disección y ligaduras**

07



**LAWRENCE**  
**07-1115.28**  
28 cm, 11"



**MEEKER**  
**07-1109.28**  
28 cm, 11"



**MIXTER**  
**07-1573.22**  
22 cm, 8 1/2"

Arterien-, Gallenkanal-, Nierenstiellklemmen  
 Hemostatic, Gall Duct and Kidney Pedicle Forceps  
 Pincas hémostatiques, pédicule renal et voies biliares  
 Pinzas hemostáticas, pedículo renal y vías biliares

07



**MIXTER**

07-1583.14	14 cm, 5 1/2"
07-1583.16	16 cm, 6 1/4"
07-1583.18	18 cm, 7"
07-1583.23	23 cm, 10"



**MIXTER-BABY**

07-1521.14	14 cm, 5 1/2"
------------	---------------



**MIXTER-BABY**

07-1521.18	18 cm, 7"
------------	-----------



**MIXTER-O'SHAUGHNESSY**

07-1523.15	15,5 cm, 6"
------------	-------------

07-1523.18	18 cm, 7"
------------	-----------



07-1563.22	22 cm, 8 1/2"
------------	---------------

07-1563.25	25 cm, 10"
------------	------------

07-1563.28	28 cm, 11"
------------	------------



**MIXTER**



Arterien-, Gallenkanal-, Nierenstielklemmen  
 Hemostatic, Gall Duct and Kidney Pedicle Forceps  
 Pincas hémostatiques, pédicule renal et voies biliares  
 Pinzas hemostáticas, pedículo renal y vías biliares



07-0840.15  
 15 cm, 5 3/4"



07-0841.15  
 15 cm, 5 3/4"



BAINBRIDGE



LAHEY

07-1551.19  
 19 cm, 7 1/2"



LAHEY

07-1551.23  
 23 cm, 9"



LOWER

07-4825.18  
 18 cm, 7"



JOHNS-HOPKINS

07-1559.20  
 20 cm, 8"

Arterien-, Gallenkanal-, Nierenstiellklemmen  
 Hemostatic, Gall Duct and Kidney Pedicle Forceps  
 Pincas hémostatiques, pédicule renal et voies biliaires  
 Pinzas hemostáticas, pedículo renal y vías biliaires



**DESJARDINS**

**07-4837.21**

21 cm, 8 1/4"



**DESJARDINS**

**07-4841.21**

21 cm, 8 1/4"



**MIXTER**

**07-1539.26**

16,5 cm, 6 1/2"



**MOYNIHAN**

**07-4865.23**

23 cm, 9"



**STILLE**

**07-4601.23**

23 cm, 9"



**MAYO-GUYON**

**07-4627.23**

23 cm, 9"

07

Arterien-, Gallenkanal-, Nierenstielklemmen  
 Hemostatic, Gall Duct and Kidney Pedicle Forceps  
 Pincas hémostatiques, pédicule renal et voies biliaires  
 Pinzas hemostáticas, pedículo renal y vías biliares

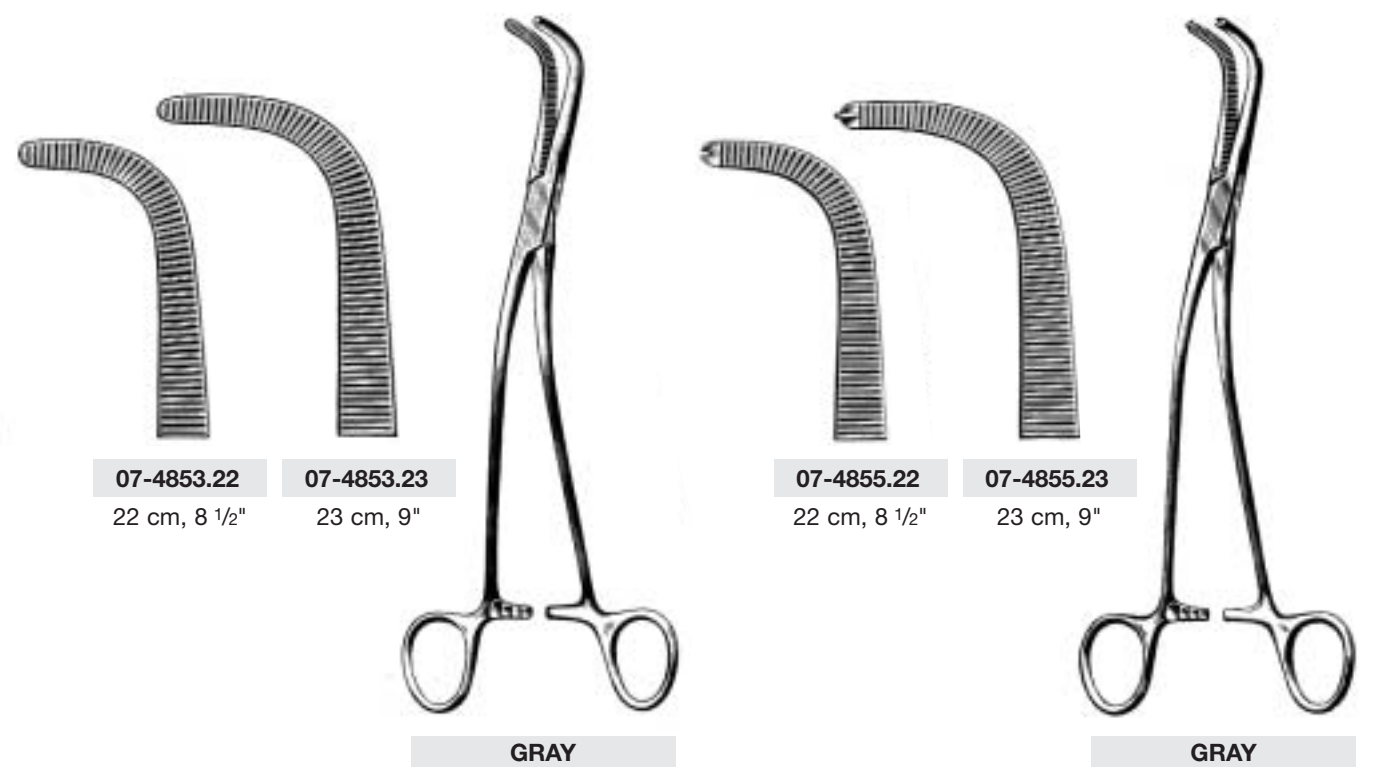

Nierenstielklemmen, Peritoneumklemmen, Hyterektomieklemmen  
 Kidney Pedicle Forceps, Peritoneum Forceps, Hyterectomy Forceps  
 Clamps rénaux, Pincas-clamps pour le péritoine, Pincas à hystérectomie  
 Pinzas-clamps renales, Pinzas-clamps para peritoneo, Pinzas-clamps para histerectomía

07



**HERRICK**  
 07-4621.23  
 23 cm, 9"



**WERTHEIM-CULLEN**  
 07-6127.21  
 21,5 cm, 8 1/4"

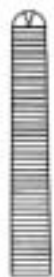

**07-6100.21**  
 21 cm, 8 1/4"



**07-6101.21**  
 21 cm, 8 1/4"



**PHANEUF**



**07-6135.23**  
 23 cm, 9"



**07-6136.23**  
 23 cm, 9"



**WERTHEIM**

**Nierenstielklemmen, Peritoneumklemmen, Hyterektomieklemmen**  
**Kidney Pedicle Forceps, Peritoneum Forceps, Hyterectomy Forceps**  
**Clamps rénaux, Pincas-clamps pour le péritoine, Pincas à hystérectomie**  
**Pinzas-clamps renales, Pinzas-clamps para peritoneo, Pinzas-clamps para histerectomía**



**MICULICZ**  
**07-6223.20**  
 20 cm, 8"



**07-6243.20**      **07-6245.20**  
 20 cm, 8"      20 cm, 8"



**FAURE**



**WERTHEIM**  
**07-4613.25**  
 25 cm, 10"



**HEANEY**  
**07-6321.20**  
 20 cm, 8"



**HEANEY**  
**07-6323.20**  
 20 cm, 8"

Schlauchklemmen  
 Tubing Clamps  
 Pincas serre-tubes  
 Pinzas-clamps para tubos

07



**MOD. BERLIN**  
**07-9906.14**  
 14,5 cm, 5 1/2"



**PRESBYTERIAN-HOSPITAL**  
**07-9912.16**  
 16 cm, 6 1/4"



**07-9900.15**  
 15 cm, 5 3/4"



**07-9900.18**  
 18 cm, 7"



**07-9900.20**  
 20 cm, 8"

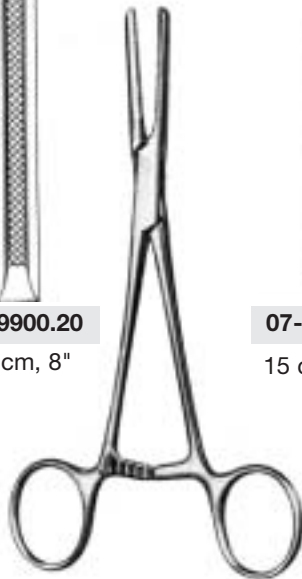

**07-9902.15**  
 15 cm, 5 3/4"



**07-9902.18**  
 18 cm, 7"



**07-9902.20**  
 20 cm, 8"

