





**GRAVE**

<b>32-1010.01</b>	Fig. 1	75 x 20 mm
<b>32-1010.02</b>	Fig. 2	95 x 35 mm
<b>32-1010.03</b>	Fig. 3	115 x 35 mm



**PEDDERSON**

<b>32-1020.01</b>	Fig. 1	75 x 13 mm
<b>32-1020.02</b>	Fig. 2	100 x 22 mm
<b>32-1020.03</b>	Fig. 3	120 x 25 mm



**COLLIN**

<b>32-1030.01</b>	Fig. 1	85 x 30 mm
<b>32-1030.02</b>	Fig. 2	100 x 35 mm
<b>32-1030.03</b>	Fig. 3	110 x 40 mm



**COLLIN**

**32-1031.00**  
 65 x 20 mm



**COLLIN**

**32-1032.00**  
 65 x 10 mm

Scheiden-Spekula  
 Vaginal Specula  
 Spéculums vaginaux  
 Espéculos vaginales



CUSCO		
32-1040.01	Fig. 1	75 x 32 mm
32-1040.02	Fig. 2	85 x 35 mm
32-1040.03	Fig. 3	100 x 35 mm



CUSCO		
32-1050.01	Fig. 1	75 x 32 mm
32-1050.02	Fig. 2	85 x 36 mm
32-1050.03	Fig. 3	95 x 37 mm



Schweizer Modell  
 Swiss Pattern  
 Modèle suisse  
 Modelo suizo

CUSCO		
32-1060.01	Fig. 1	90 x 23-25 mm
32-1060.02	Fig. 2	100 x 25-27 mm
32-1060.03	Fig. 3	110 x 27-30 mm



CUSCO		
32-1042.00		75 x 17 mm

Scheiden-Spekula  
 Vaginal Specula  
 Spéculum vaginaux  
 Espéculos vaginales



**TRELAT**

<b>32-1080.01</b>	Fig. 1	85 x 33 mm
<b>32-1080.02</b>	Fig. 2	95 x 35 mm
<b>32-1080.03</b>	Fig. 3	115 x 43 mm



**SEMM**

<b>32-1090.01</b>	100 x 17-20 mm
<b>32-1090.02</b>	100 x 25-30 mm



Satz  
 Set  
 Jeu  
 Juego

**KRISTELLER**

<b>32-1110.01</b>	Fig. 1
<b>32-1110.02</b>	Fig. 2
<b>32-1110.03</b>	Fig. 3

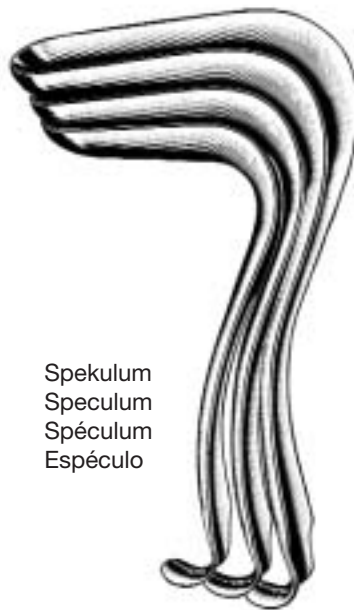

Spekulum  
 Speculum  
 Spéculum  
 Espéculo

**KRISTELLER**

<b>32-1111.01</b>	Fig. 1
<b>32-1111.02</b>	Fig. 2
<b>32-1111.03</b>	Fig. 3

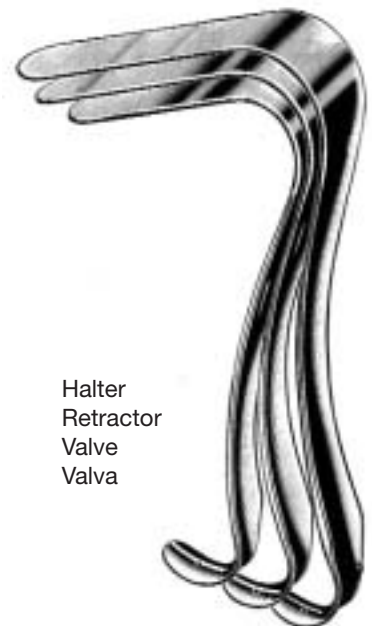

Halter  
 Retractor  
 Valve  
 Valva

**KRISTELLER**

<b>32-1112.01</b>	Fig. 1
<b>32-1112.02</b>	Fig. 2
<b>32-1112.03</b>	Fig. 3

**Scheiden-Spekula**  
**Vaginal Specula**  
**Spéculums vaginaux**  
**Espéculos vaginales**

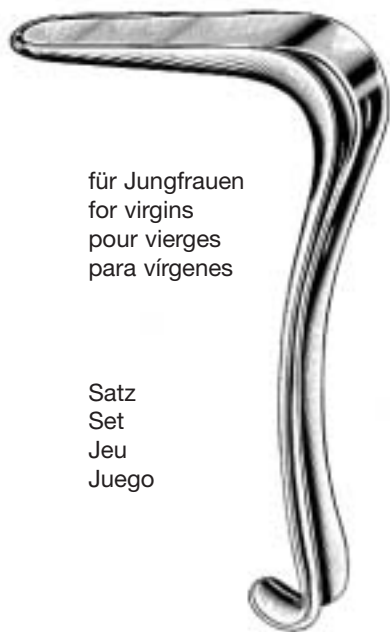

für Jungfrauen  
 for virgins  
 pour vierges  
 para vírgenes

Satz  
 Set  
 Jeu  
 Juego

**KRISTELLER**

**32-1120.01** Fig. 1

**32-1120.02** Fig. 2

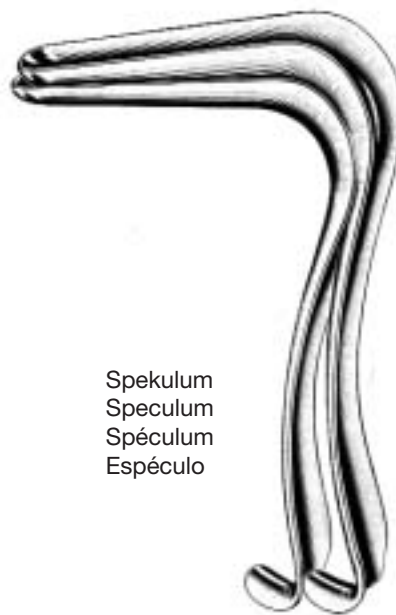

Spekulum  
 Speculum  
 Spéculum  
 Espéculo

**KRISTELLER**

**32-1121.01** Fig. 1

**32-1121.02** Fig. 2



Halter  
 Retractor  
 Valve  
 Valva

**KRISTELLER**

**32-1122.01** Fig. 1

**32-1122.02** Fig. 2



Satz  
 Set  
 Jeu  
 Juego

**KRISTELLER**

**32-1130.01** Fig. 1

**32-1130.02** Fig. 2

**32-1130.03** Fig. 3

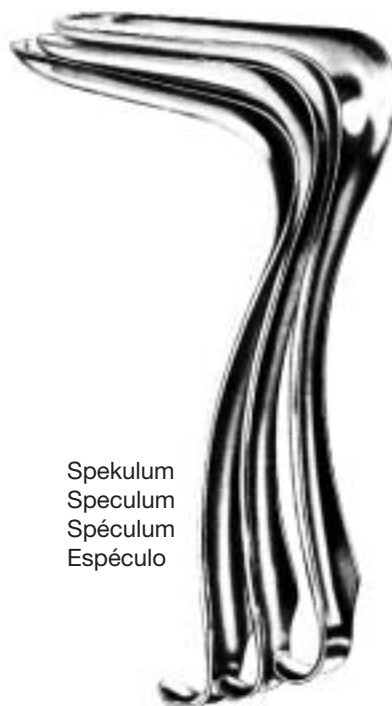

Spekulum  
 Speculum  
 Spéculum  
 Espéculo

**KRISTELLER**

**32-1131.01** Fig. 1

**32-1131.02** Fig. 2

**32-1131.03** Fig. 3

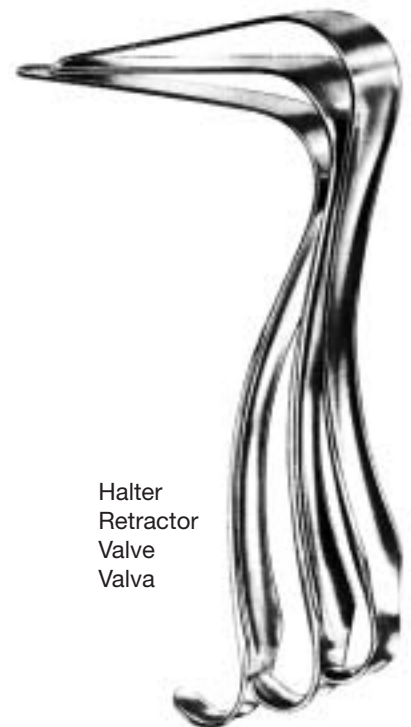

Halter  
 Retractor  
 Valve  
 Valva

**KRISTELLER**

**32-1132.01** Fig. 1

**32-1132.02** Fig. 2

**32-1132.03** Fig. 3

Scheiden-Spekula  
 Vaginal Specula  
 Spéculum vaginaux  
 Espéculos vaginales

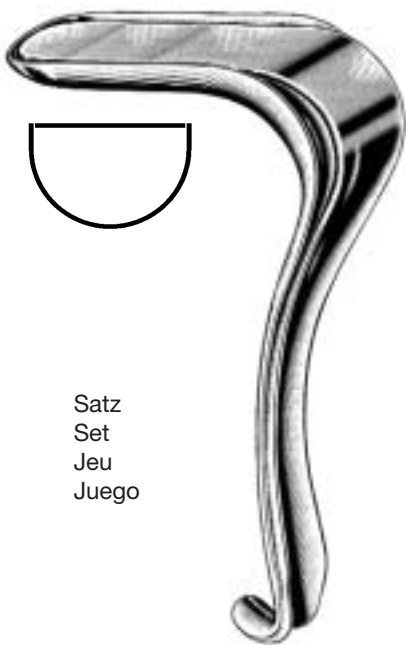

Satz  
 Set  
 Jeu  
 Juego

**KRISTELLER**

32-1140.01 Fig. 1

32-1140.02 Fig. 2

32-1140.03 Fig. 3

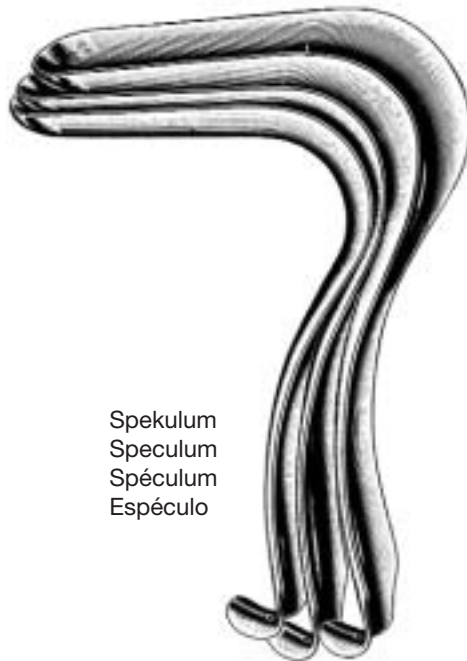

Spekulum  
 Speculum  
 Spéculum  
 Espéculo

**KRISTELLER**

32-1141.01 Fig. 1

32-1141.02 Fig. 2

32-1141.03 Fig. 3

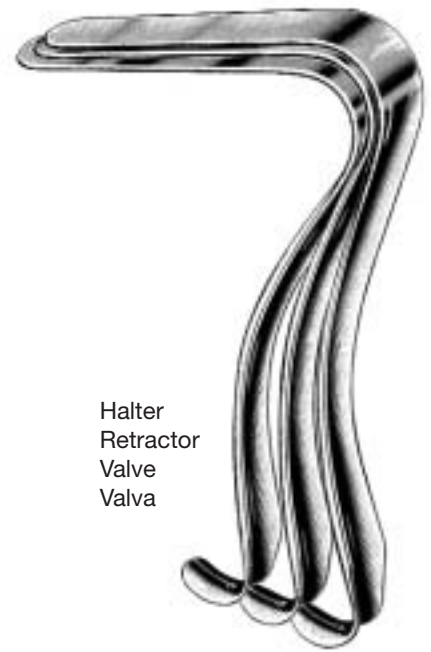

Halter  
 Retractor  
 Valve  
 Valva

**KRISTELLER**

32-1142.01 Fig. 1

32-1142.02 Fig. 2

32-1142.03 Fig. 3



Satz  
 Set  
 Jeu  
 Juego

**KRISTELLER**

32-1150.00

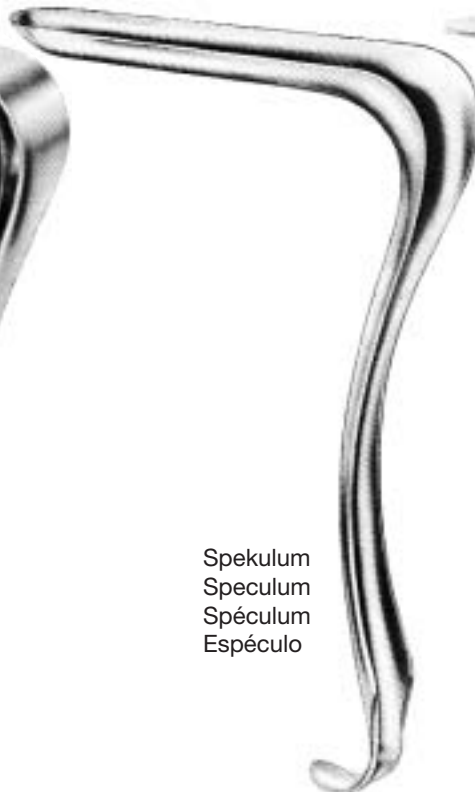

Spekulum  
 Speculum  
 Spéculum  
 Espéculo

**KRISTELLER**

32-1151.00

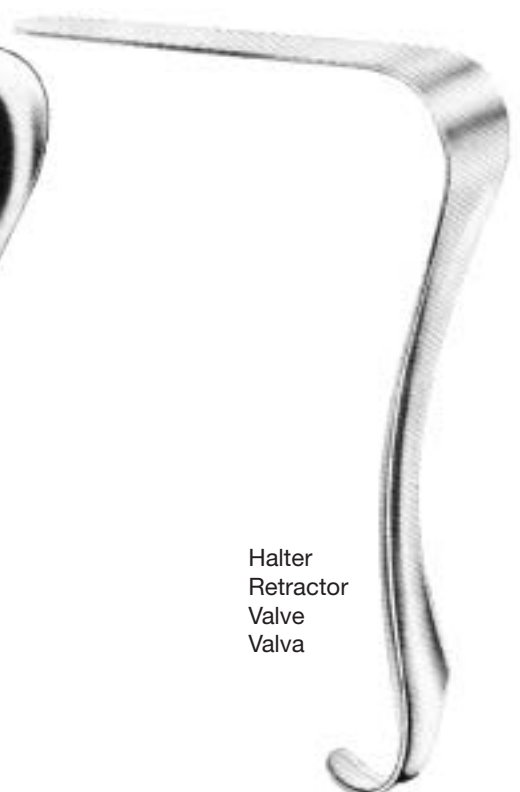

Halter  
 Retractor  
 Valve  
 Valva

**KRISTELLER**

32-1152.00

Scheiden-Spekula  
 Vaginal Specula  
 Spéculums vaginaux  
 Espéculos vaginales



Satz  
 Set  
 Jeu  
 Juego

**KALLMORGEN**

32-1160.01 Fig. 1

32-1160.02 Fig. 2

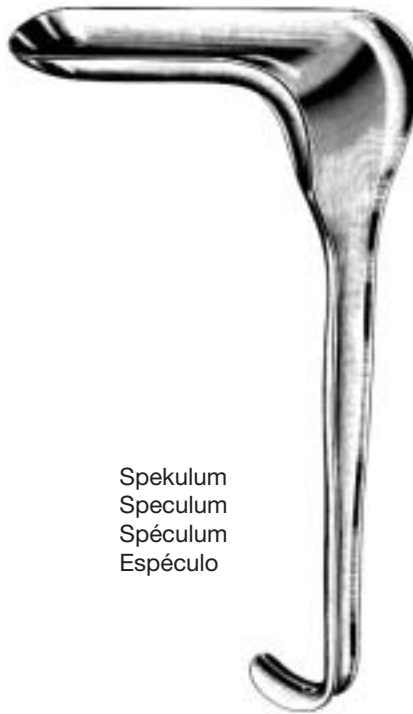

Spekulum  
 Speculum  
 Spéculum  
 Espéculo

**KALLMORGEN**

32-1161.01 Fig. 1

32-1161.02 Fig. 2

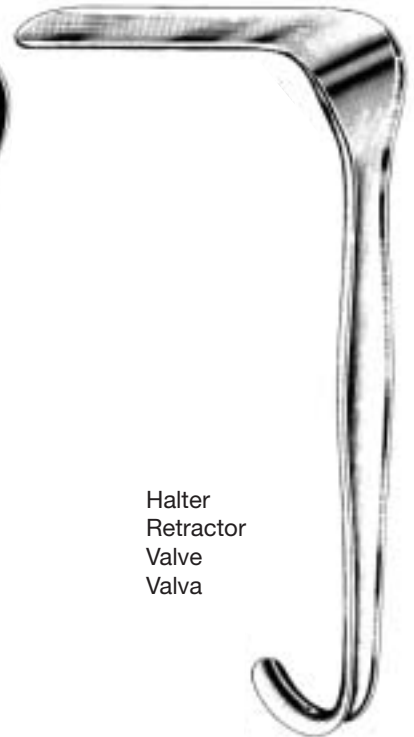

Halter  
 Retractor  
 Valve  
 Valva

**KALLMORGEN**

32-1162.01 Fig. 1

32-1162.02 Fig. 2



**JACKSON**

32-1171.01 Fig. 1 75 x 38 mm

32-1171.02 Fig. 2 90 x 38 mm

32-1171.03 Fig. 3 100 x 38 mm



**SIMS**

32-1181.01 Fig. 1

32-1181.02 Fig. 2

32-1181.03 Fig. 3



**SIMS**

32-1191.00 Set

32-1191.01 Fig. 1

32-1191.02 Fig. 2

32-1191.03 Fig. 3

Scheiden-Spekula  
 Vaginal Specula  
 Spéculums vaginaux  
 Espéculos vaginales

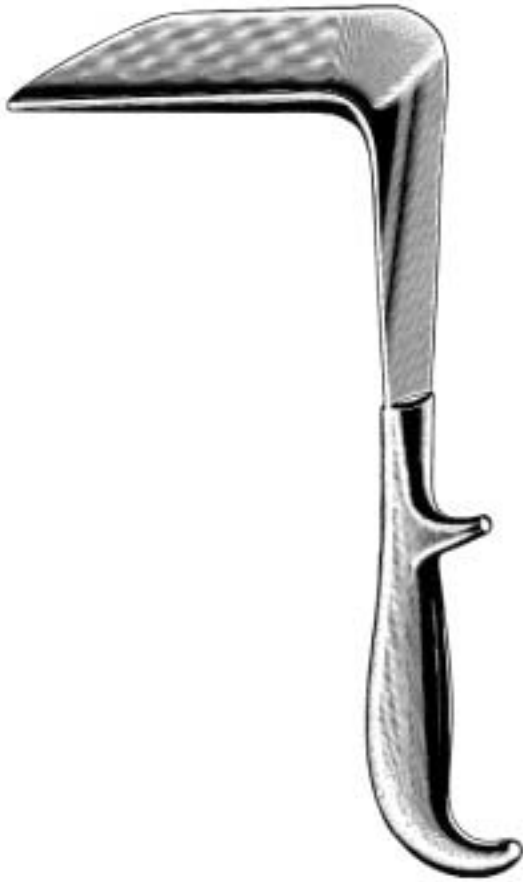

DOYEN

32-1201.01	Fig. 1	55 x 35 mm
32-1201.02	Fig. 2	85 x 35 mm
32-1201.03	Fig. 3	115 x 35 mm
32-1203.01	Fig. 1	55 x 45 mm
32-1203.02	Fig. 2	85 x 45 mm
32-1203.03	Fig. 3	115 x 45 mm
32-1203.04	Fig. 4	160 x 45 mm
32-1205.01	Fig. 1	55 x 60 mm
32-1205.02	Fig. 2	85 x 60 mm
32-1205.03	Fig. 3	115 x 60 mm
32-1205.04	Fig. 4	160 x 60 mm



mit abnehmbarem Gewicht  
 with detachable weight  
 avec poids démontable  
 con peso desmontable

AUVARD

32-1507.00



mit festem Gewicht  
 with fixed weight  
 avec poids fixe  
 con peso fijo

AUVARD

32-1509.00





**BREISKY**

<b>32-1510.20</b>	100 x 20 mm
<b>32-1510.25</b>	100 x 25 mm
<b>32-1510.30</b>	100 x 30 mm
<b>32-1510.35</b>	100 x 35 mm
<b>32-1510.40</b>	100 x 40 mm
<b>32-1513.20</b>	130 x 20 mm
<b>32-1513.25</b>	130 x 25 mm
<b>32-1513.30</b>	130 x 30 mm
<b>32-1513.35</b>	130 x 35 mm
<b>32-1513.40</b>	130 x 40 mm
<b>32-1515.40</b>	155 x 40 mm



**LANDAU**

<b>32-1519.28</b>	100 x 28 mm
<b>32-1519.38</b>	100 x 38 mm



**KOGAN**

<b>32-1560.24</b>	24 cm, 9 1/2"
-------------------	---------------



**FRIEDMANN**

<b>32-1551.10</b>	10 cm, 4"
-------------------	-----------

**Uterus-Dilatatoren**  
**Uterine Dilators**  
**Dilatateurs utérins**  
**Dilatadores uterinos**



32-1610.01	1 mm	32-1610.16	16 mm
32-1610.02	2 mm	32-1610.17	17 mm
32-1610.03	3 mm	32-1610.18	18 mm
32-1610.04	4 mm	32-1610.19	19 mm
32-1610.05	5 mm	32-1610.20	20 mm
32-1610.06	6 mm	32-1610.21	21 mm
32-1610.07	7 mm	32-1610.22	22 mm
32-1610.08	8 mm	32-1610.23	23 mm
32-1610.09	9 mm	32-1610.24	24 mm
32-1610.10	10 mm	32-1610.25	25 mm
32-1610.11	11 mm	32-1610.26	26 mm
32-1610.12	12 mm	32-1610.27	27 mm
32-1610.13	13 mm	32-1610.28	28 mm
32-1610.14	14 mm	32-1610.29	29 mm
32-1610.15	15 mm	32-1610.30	30 mm

HEGAR

HEGAR

32-1604.14 4 - 17 mm

32-1604.26 1 - 26 mm



32-1615.01	1,5 mm
32-1615.02	2,5 mm
32-1615.03	3,5 mm
32-1615.04	4,5 mm
32-1615.05	5,5 mm
32-1615.06	6,5 mm
32-1615.07	7,5 mm
32-1615.08	8,5 mm
32-1615.09	9,5 mm
32-1615.10	10,5 mm
32-1615.11	11,5 mm
32-1615.12	12,5 mm
32-1615.13	13,5 mm
32-1615.14	14,5 mm
32-1615.15	15,5 mm
32-1615.16	16,5 mm

HEGAR



HEGAR

32-1605.14 4 - 17 mm



HEGAR

32-1606.14 4 - 17 mm

32-1606.26 1 - 26 mm

**Uterus-Dilatatoren**  
**Uterine Dilators**  
**Dilatateurs utérins**  
**Dilatadores uterinos**



**HEGAR**

<b>32-1620.01</b>	1/2 mm
<b>32-1620.03</b>	3/4 mm
<b>32-1620.05</b>	5/6 mm
<b>32-1620.07</b>	7/8 mm
<b>32-1620.09</b>	9/10 mm
<b>32-1620.11</b>	11/12 mm
<b>32-1620.13</b>	13/14 mm
<b>32-1620.15</b>	15/16 mm
<b>32-1620.17</b>	17/18 mm
<b>32-1620.19</b>	19/20 mm
<b>32-1620.21</b>	21/22 mm
<b>32-1620.23</b>	23/24 mm
<b>32-1620.25</b>	25/26 mm

**HEGAR**

<b>32-1624.08</b>	3/4 - 17/18 mm
<b>32-1624.13</b>	1/2 - 25/26 mm

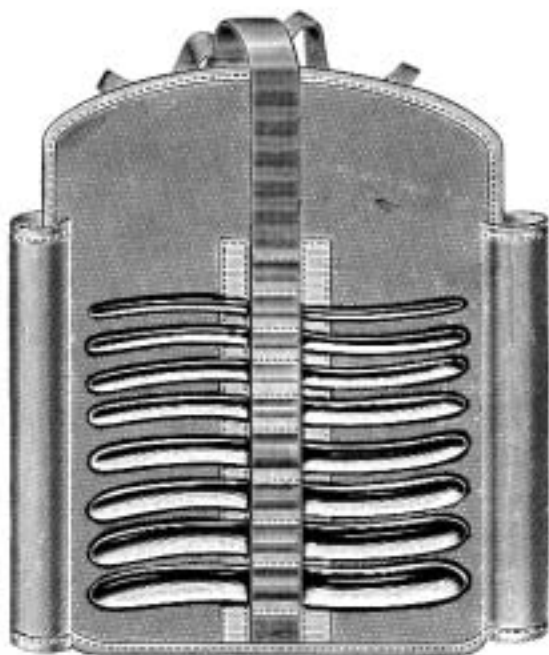

**HEGAR**

<b>32-1625.08</b>	3/4 - 17/18 mm
-------------------	----------------



**HEGAR**

<b>32-1626.08</b>	3/4 - 17/18 mm
<b>32-1626.13</b>	1/2 - 25/26 mm

**Uterus-Dilatatoren**  
**Uterine Dilators**  
**Dilatateurs utérins**  
**Dilatadores uterinos**



**HANK**  
**32-1635.06**  
 4,5/5 - 9,5/10 mm

HANK	
32-1630.10	4,5/5 mm
32-1630.12	5,5/6 mm
32-1630.14	6,5/7 mm
32-1630.16	7,5/8 mm
32-1630.18	8,5/9 mm
32-1630.20	9,5/10 mm

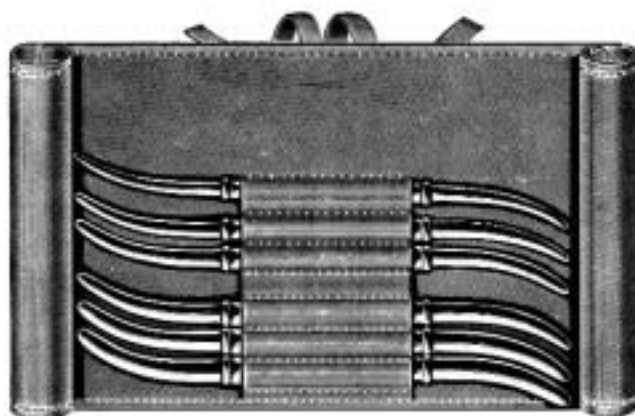

**HANK**  
**32-1636.08**



**GOODELL**  
**32-1641.34**  
 34 cm, 13 1/4"



**WYLIE**  
**32-1643.29**  
 29 cm, 11 1/4"



**SIMS**  
**32-1645.29**  
 29 cm, 11 1/4"

32

**Hakenzangen**  
**Tenaculum Forceps**  
**Pinces pour abaissement du col de l'utérus**  
**Pinzas para coger el cuello del útero**



**SCHROEDER**

**32-1702.25**

25 cm, 10"



**BRAUN**

**32-1704.25**

25 cm, 10"



**SKENE**

**32-1705.24**

24 cm, 9 1/2"



**DUPLAY**

**32-1707.28**

28 cm, 11"



**STAUDE-MOORE**

**32-1708.17**

17 cm, 6 3/4"



**BARRETT**

**32-1710.18**

18 cm, 7"

**Hakenzangen**  
**Tenaculum Forceps**  
**Pinces pour abaissement du col de l'utérus**  
**Pinzas para coger el cuello del útero**



**JARCHO**  
**32-1712.20**  
 20 cm, 8"



**SCHROEDER**  
**32-1714.24**  
 24 cm, 9 1/2"



**SCHROEDER**  
**32-1715.24**  
 24 cm, 9 1/2"



**MUSEUX**  
 24 cm, 9 1/2"



**32-1724.06**  
 6 mm



**32-1724.08**  
 8 mm



**32-1724.10**  
 10 mm



**MUSEUX**  
 24 cm, 9 1/2"



**32-1725.06**  
 6 mm



**32-1725.08**  
 8 mm



**32-1725.10**  
 10 mm

**Hakenzangen**  
**Tenaculum Forceps**  
**Pinces pour abaissement du col de l'utérus**  
**Pinzas para coger el cuello del útero**



**TEALE**  
**32-1731.23**

23 cm, 9"



**JACOBS**  
**32-1732.21**

21 cm, 8 1/4"



**JACOBS**  
**32-1733.21**

21 cm, 8 1/4"

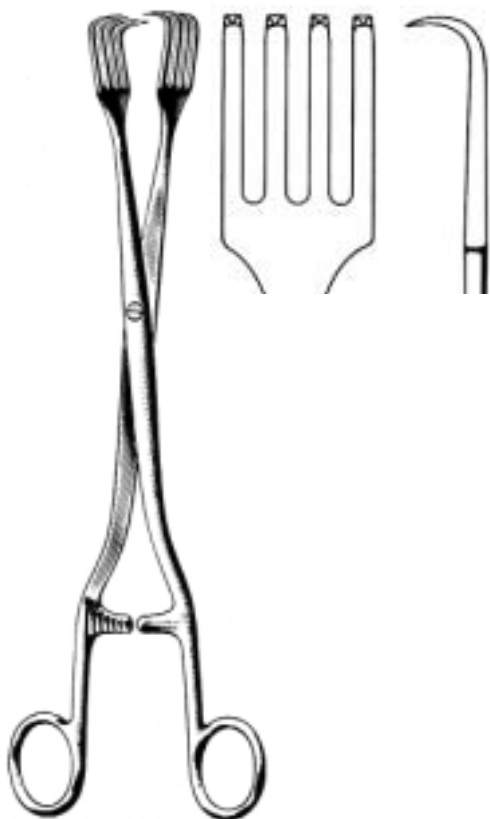

**PRATT**  
**32-1736.28**

28 cm, 11"



**IOWA**  
**32-1739.26**

26 cm, 10 1/4"



Amniotom  
 Amniotome  
 Amniotome  
 Amniótomo

**BEACHAM**  
**32-1759.26**

26 cm, 10 1/4"



**NOTO**

**32-1740.27**

27 cm, 10 1/2"



**DOYEN**

**32-1742.20**

20 cm, 8"



**KELLY**

**32-1743.32**

32 cm, 12 3/4"



**DARTIGUES**

**32-1745.27**

27 cm, 10 1/2"



**SOMER**

**32-1747.23**

23 cm, 9"



**COLLIN**

**32-1749.25**

25 cm, 10"





**BRAUN**  
 32-1765.28  
 28 cm, 11"



**SIMS**  
 32-1767.26  
 26 cm, 10 1/4"



**COLLIN**  
 32-1784.28  
 28 cm, 11"



starr  
 rigid  
 rigide  
 rígida

**SIMS**  
 32-1780.32

32 cm, 12 3/4"



biegsam  
 malleable  
 malléable  
 maleable

**SIMS**  
 32-1781.32

32 cm, 12 3/4"



starr  
 rigid  
 rigide  
 rígida

**MARTIN**  
 32-1782.32

32 cm, 12 3/4"



biegsam  
 malleable  
 malléable  
 maleable

**MARTIN**  
 32-1783.32

32 cm, 12 3/4"



**RANDALL**

**32-1790.04**

24 cm, 9 1/2"



**NOVAK**

**32-1792.01** 1 mm

**32-1792.02** 2 mm

**32-1792.03** 3 mm

**32-1792.04** 4 mm

24 cm, 9 1/2"



**KEVORKIAN**

**32-1794.12** 1,2 mm

**32-1794.40** 4,0 mm

30 cm, 12"



4,0 mm

**KEVORKIAN**

**32-1796.40**

30 cm, 12"

**Biopsiezangen**  
**Biopsy Specimen Forceps**  
**Pinces à biopsie**  
**Pinzas sacabocados para biopsia**



**FAURE**  
**32-1801.21**  
 21 cm, 8 1/4"



**SCHUBERT**  
**32-1804.21** 21 cm, 8 1/4"  
**32-1804.28** 28 cm, 11"



**SCHUBERT**  
**32-1805.26**  
 26 cm, 10 1/4"



**THOMS-GAYLOR**  
**32-1806.24**  
 24 cm, 9 1/2"



**GELLHORN**  
**32-1809.23**  
 23 cm, 9"



**VAN DOREN**  
**32-1811.25**  
 25 cm, 10"

**Biopsiezangen**  
**Biopsy Specimen Forceps**  
**Pinces à biopsie**  
**Pinzas sacabocados para biopsia**

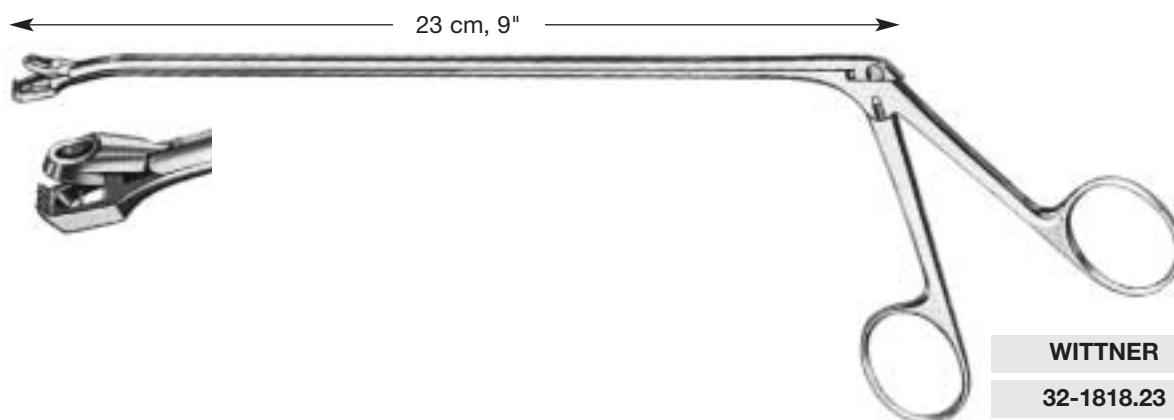
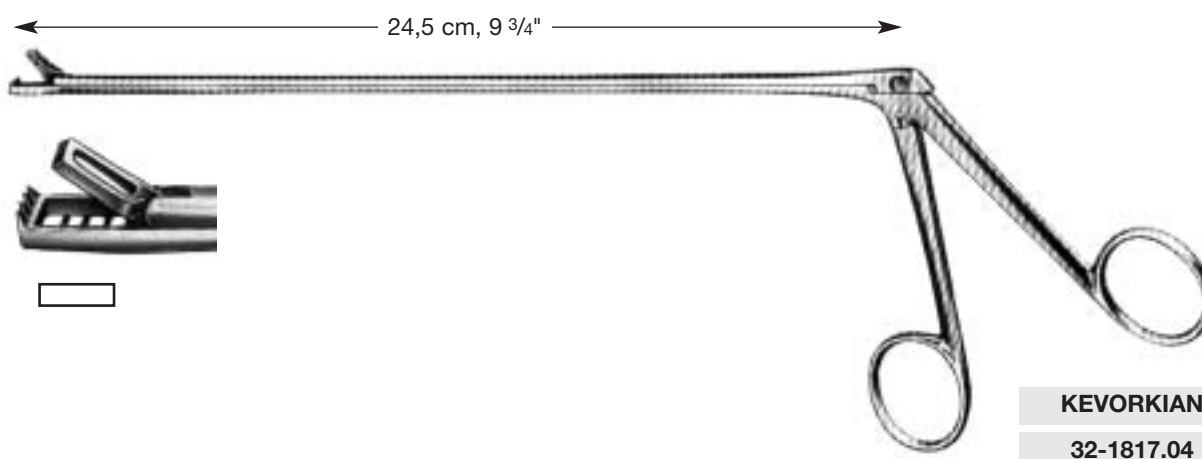
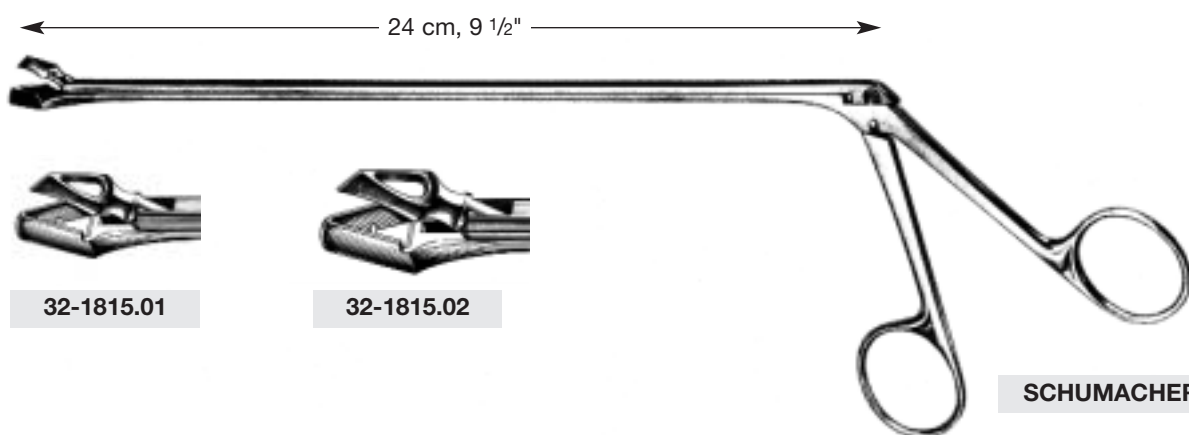
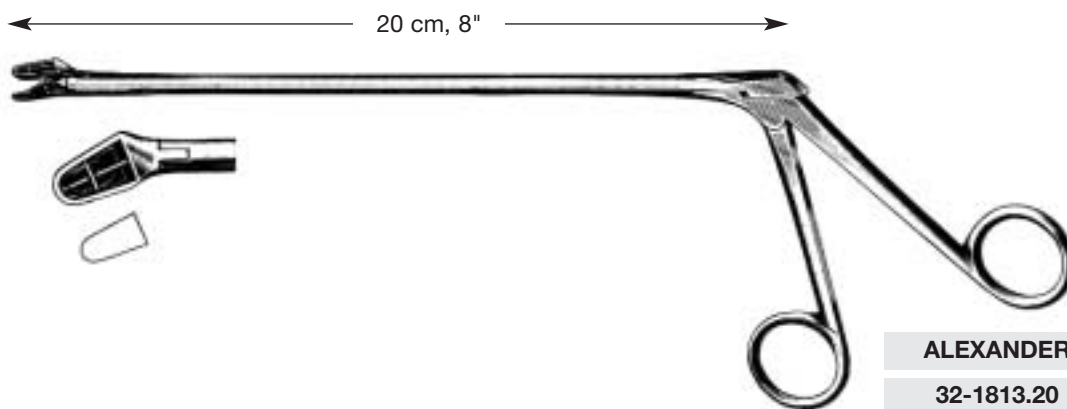

32

**Biopsiezangen**  
**Biopsy Specimen Forceps**  
**Pinces à biopsie**  
**Pinzas sacabocados para biopsia**

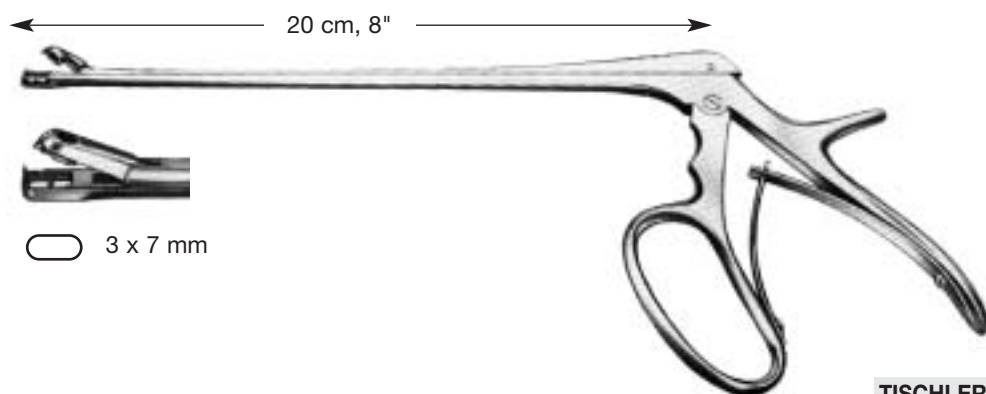

**TISCHLER-MORGAN**

**32-1821.01**

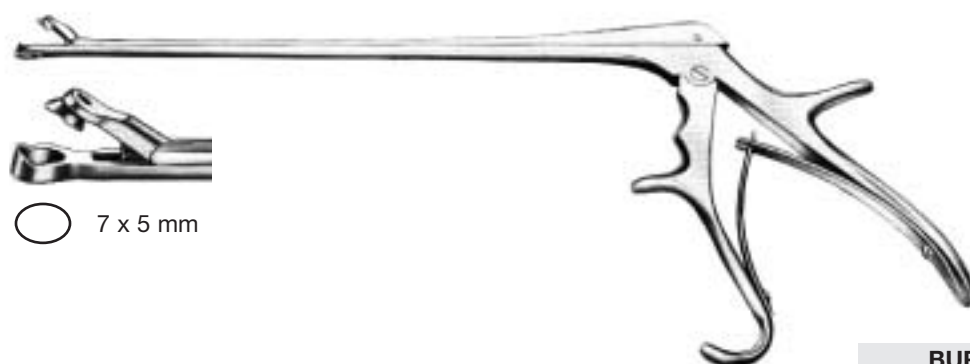

**BURKE**

**32-1822.00**

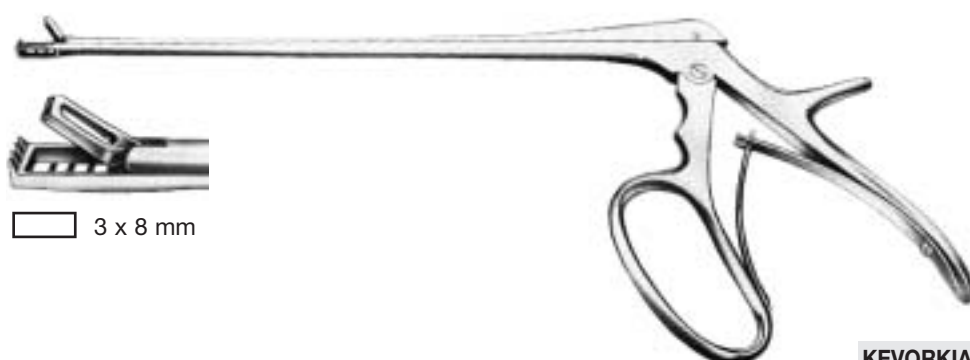

**KEVORKIAN-PACIFIC**

**32-1825.04**

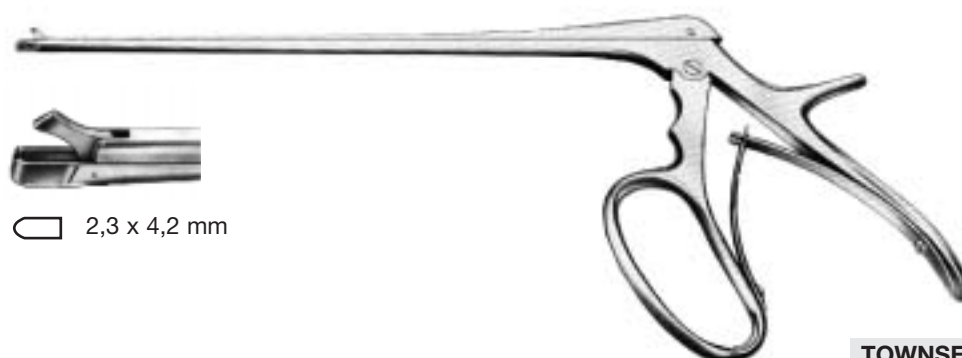

**TOWNSEND-MINI**

**32-1826.00**

**Biopsiezangen**  
**Biopsy Specimen Forceps**  
**Pinces à biopsie**  
**Pinzas sacabocados para biopsia**



Instrument komplett  
 Instrument complete  
 Instrument complet  
 Instrumento completo

Aufsatz allein  
 Tip only  
 Embout seul  
 Punta sola

**TOWNSEND-TISCHLER**

**32-1824.01**

**32-1824.11**



Instrument komplett  
 Instrument complete  
 Instrument complet  
 Instrumento completo

Aufsatz allein  
 Tip only  
 Embout seul  
 Punta sola

**TOWNSEND**

**32-1824.02**

**32-1824.12**



Instrument komplett  
 Instrument complete  
 Instrument complet  
 Instrumento completo

Aufsatz allein  
 Tip only  
 Embout seul  
 Punta sola

**TOWNSEND**

**32-1824.03**

**32-1824.13**



Instrument komplett  
 Instrument complete  
 Instrument complet  
 Instrumento completo

Aufsatz allein  
 Tip only  
 Embout seul  
 Punta sola

**TOWNSEND-KEVORKIAN**

**32-1824.04**

**32-1824.14**

**Biopsiezangen**  
**Biopsy Specimen Forceps**  
**Pinces à biopsie**  
**Pinzas sacabocados para biopsia**

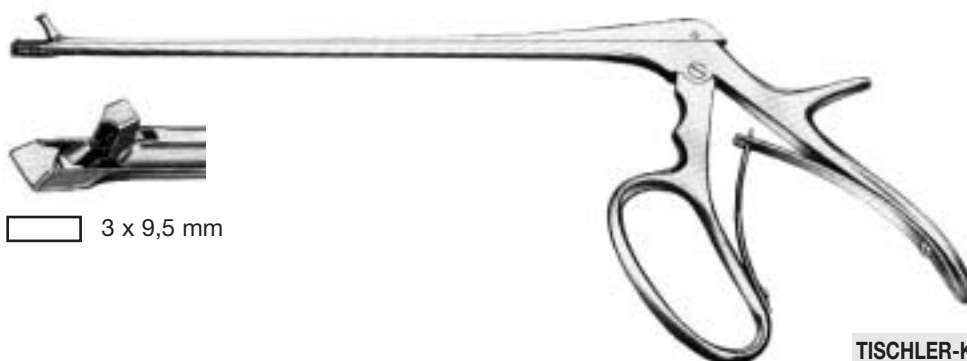

3 x 9,5 mm

**TISCHLER-KEVORKIAN**

**32-1827.00**

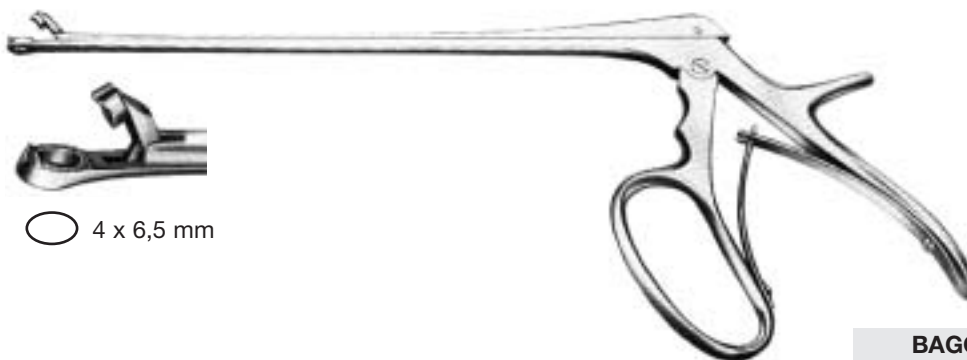

4 x 6,5 mm

**BAGGISH**

**32-1828.00**

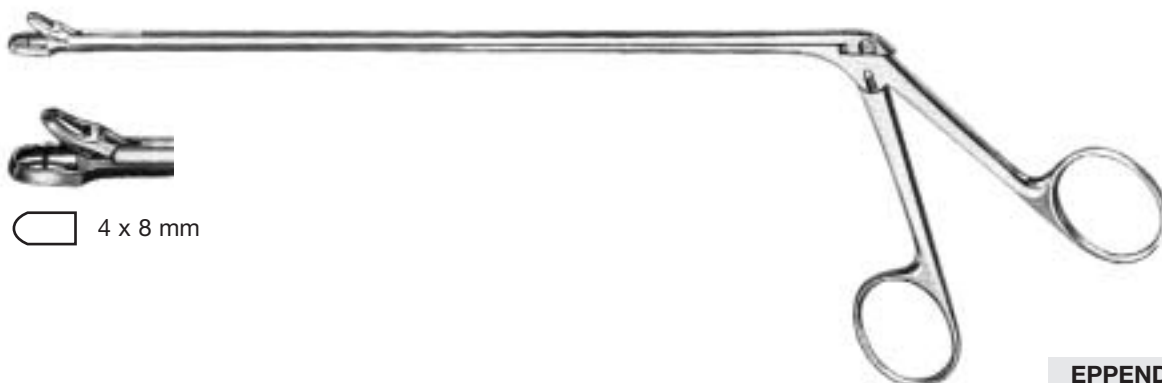

4 x 8 mm

**EPPENDORFER**

**32-1830.00**

**Biopsiezangen**  
**Biopsy Specimen Forceps**  
**Pinces à biopsie**  
**Pinzas sacabocados para biopsia**



**EPPENDORFER**



Instrument komplett  
 Instrument complete  
 Instrument complet  
 Instrumento completo

Aufsatz allein  
 Tip only  
 Embout seul  
 Punta sola

**TISCHLER-MORGAN**

**32-1832.01**

**32-1832.11**



Instrument komplett  
 Instrument complete  
 Instrument complet  
 Instrumento completo

Aufsatz allein  
 Tip only  
 Embout seul  
 Punta sola

**EPPENDORFER**

**32-1832.02**

**32-1832.12**



Instrument komplett  
 Instrument complete  
 Instrument complet  
 Instrumento completo

Aufsatz allein  
 Tip only  
 Embout seul  
 Punta sola

**EPPENDORFER**

**32-1832.03**

**32-1832.13**



Instrument komplett  
 Instrument complete  
 Instrument complet  
 Instrumento completo

Aufsatz allein  
 Tip only  
 Embout seul  
 Punta sola

**KEVORKIAN**

**32-1832.04**

**32-1832.14**





**DOYEN**  
**32-1841.17**  
 17 cm, 6 3/4"



**SEGOND**  
**32-1843.27**  
 27 cm, 10 1/2"



**EMMET**  
 22 cm, 8 1/2"

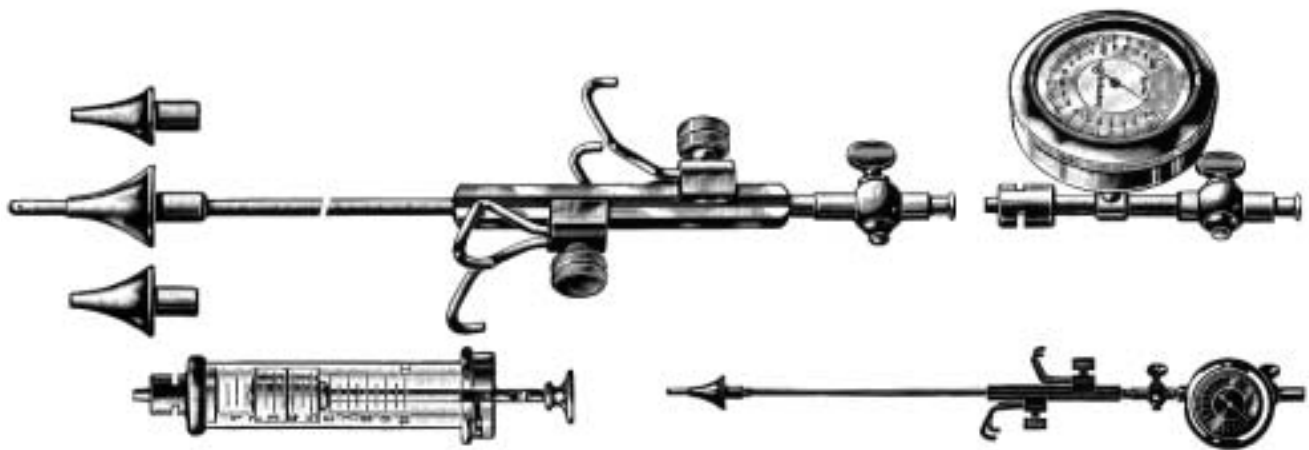
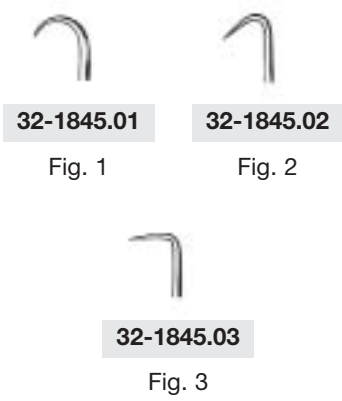

**SCHULTZE**  
**32-1850.00**  
 Salpingograph  
 Salpingograph  
 Salpingographe  
 Salpingógrafo



32-1902.01

Fig. 1



32-1902.02

Fig. 2



32-1902.03

Fig. 3



32-1902.04

Fig. 4



32-1902.05

Fig. 5



32-1902.06

Fig. 6



**SIMON**

25 cm, 10"



**BLAKE**

32-1904.27

27 cm, 10 1/2"

32

**Uterus-Küretten**  
**Uterine Curettes**  
**Curettes utérines**  
**Curetas uterinas**

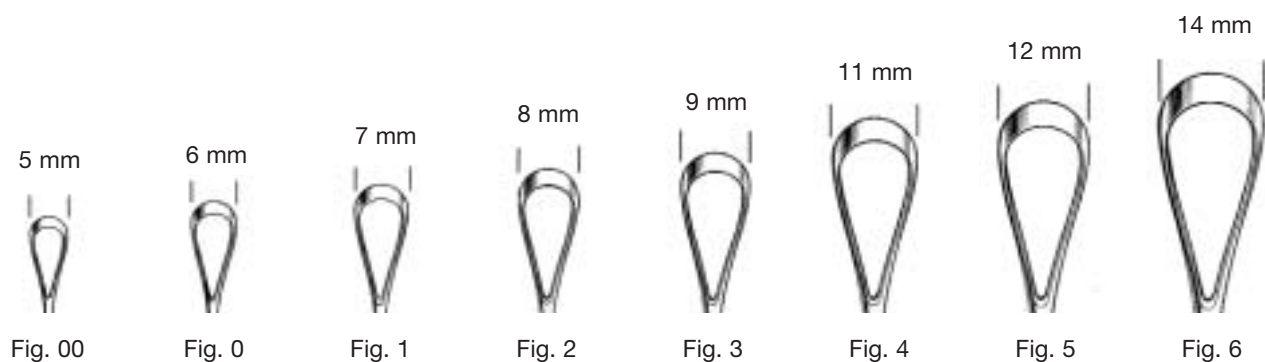

**SIMS**

28 cm, 11"

scharf, fest  
 sharp, rigid  
 tranchantes, rigides  
 cortantes, rígidas

stumpf, fest  
 blunt, rigid  
 mouses, rigides  
 romas, rígidas

scharf, biegsam  
 sharp, malleable  
 tranchantes, malléables  
 cortantes, maleables

stumpf, biegsam  
 blunt, malleable  
 mouses, malléables  
 romas, maleables

Fig. 00	32-1912.05		32-1914.05		32-1913.05		32-1915.05
Fig. 0	32-1912.06		32-1914.06		32-1913.06		32-1915.06
Fig. 1	32-1912.07		32-1914.07		32-1913.07		32-1915.07
Fig. 2	32-1912.08		32-1914.08		32-1913.08		32-1915.08
Fig. 3	32-1912.09		32-1914.09		32-1913.09		32-1915.09
Fig. 4	32-1912.11		32-1914.11		32-1913.11		32-1915.11
Fig. 5	32-1912.12		32-1914.12		32-1913.12		32-1915.12
Fig. 6	32-1912.14		32-1914.14		32-1913.14		32-1915.14

**Uterus-Küretten**  
**Uterine Curettes**  
**Curettes utérines**  
**Curetas uterinas**

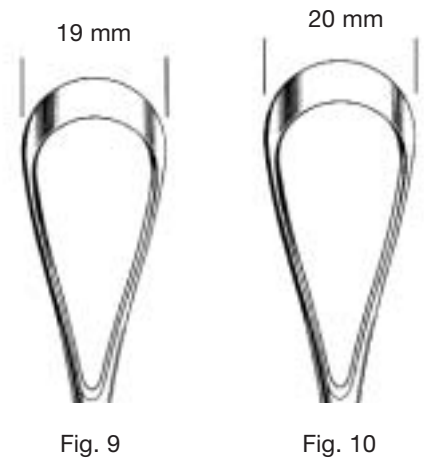
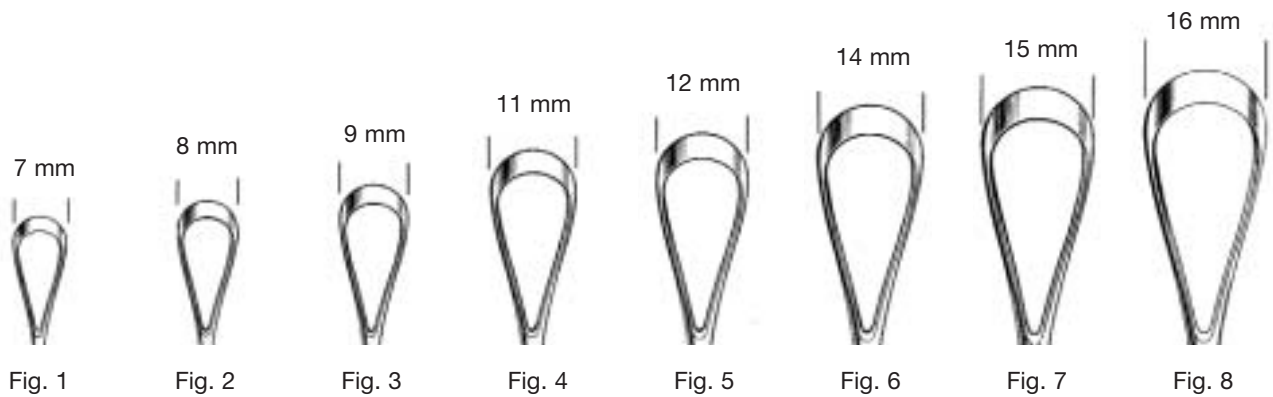

scharf, fest  
sharp, rigid  
tranchantes, rigides  
cortantes, rígidas

stumpf, fest  
blunt, rigid  
mousses, rigides  
romas, rígidas

scharf, biegsam  
sharp, malleable  
tranchantes, malléables  
cortantes, maleables

stumpf, biegsam  
blunt, malleable  
mousses, malléables  
romas, maleables

Fig. 1	32-1922.07	32-1924.07	32-1925.07	32-1927.07
Fig. 2	32-1922.08	32-1924.08	32-1925.08	32-1927.08
Fig. 3	32-1922.09	32-1924.09	32-1925.09	32-1927.09
Fig. 4	32-1922.11	32-1924.11	32-1925.11	32-1927.11
Fig. 5	32-1922.12	32-1924.12	32-1925.12	32-1927.12
Fig. 6	32-1922.14	32-1924.14	32-1925.14	32-1927.14
Fig. 7	32-1922.15	32-1924.15	32-1925.15	32-1927.15
Fig. 8	32-1922.16	32-1924.16	32-1925.16	32-1927.16
Fig. 9	32-1922.19	32-1924.19	32-1925.19	32-1927.19
Fig. 10	32-1922.20	32-1924.20	32-1925.20	32-1927.20

**RECAMIER**

31 cm, 12 1/2"

**Uterus-Küretten**  
**Uterine Curettes**  
**Curettes utérines**  
**Curetas uterinas**



Fig. 14



Fig. 15



Fig. 16



**BUMM**

28 cm, 11"

scharf, fest  
 sharp, rigid  
 tranchantes, rigides  
 cortantes, rígidas

stumpf, fest  
 blunt, rigid  
 mouses, rigides  
 romas, rígidas

scharf, biegsam  
 sharp, malleable  
 tranchantes, malléables  
 cortantes, maleables

stumpf, biegsam  
 blunt, malleable  
 mouses, malléables  
 romas, maleables

Fig. 14	<b>32-1932.30</b>	<b>32-1934.30</b>	<b>32-1933.30</b>	<b>32-1935.30</b>
Fig. 15	<b>32-1932.35</b>	<b>32-1934.35</b>	<b>32-1933.35</b>	<b>32-1935.35</b>
Fig. 16	<b>32-1932.40</b>	<b>32-1934.40</b>	<b>32-1933.40</b>	<b>32-1935.40</b>

